

Le Pro de l'entrepôt



RAYONNAGE À PALETTE



TU

TI

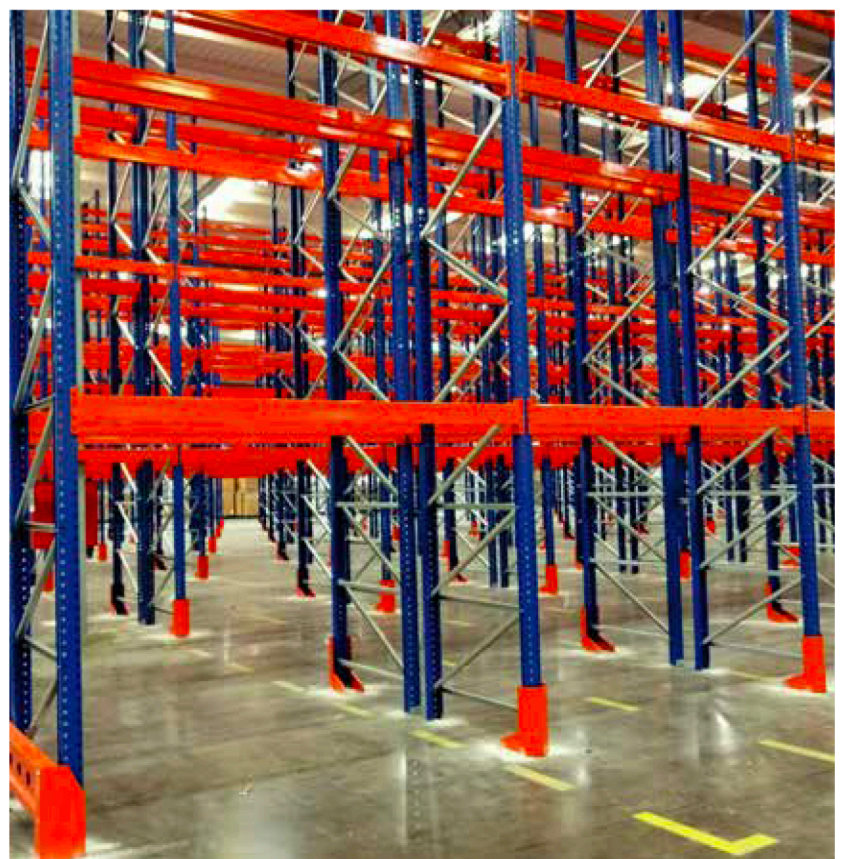

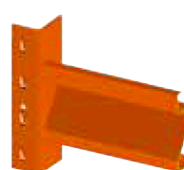
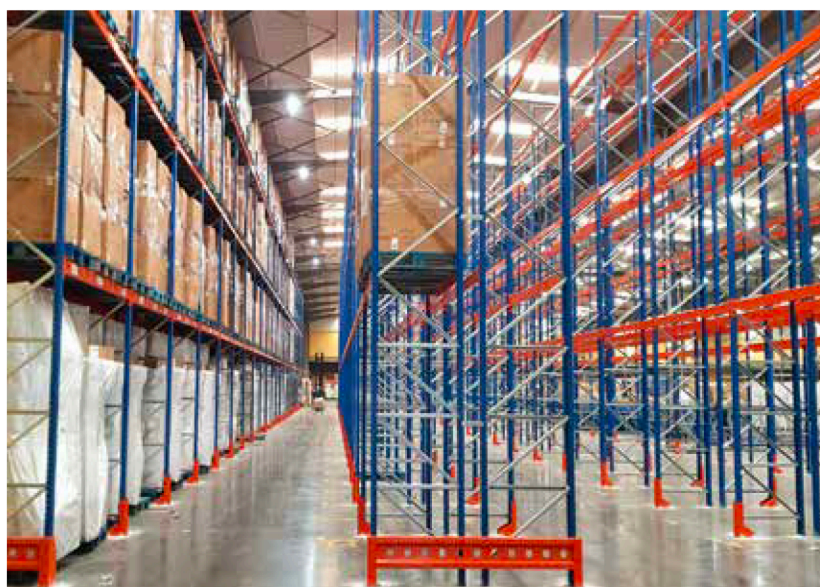

Viga LT110
Lisse



Viga LT150
Lisse



Viga LT125
Lisse

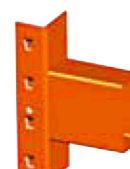

Viga LT95
Lisse

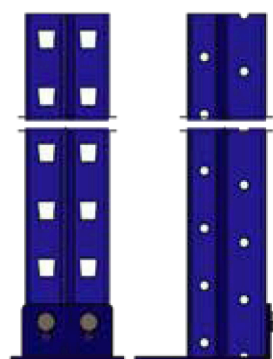

Pilar LT75
Montant LT75

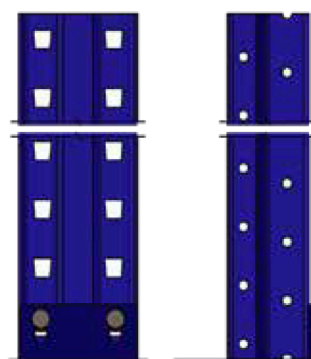

Pilar LT100
Montant LT100

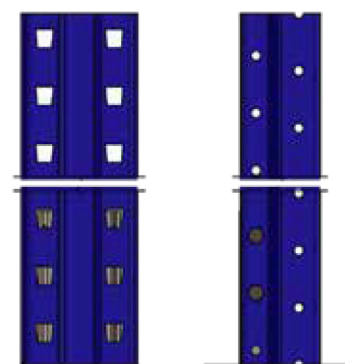

Pilar LT125
Montant LT125



Rayonnage dynamique pour les boîtes. Rack de chargement manuel, composé de convoyeurs à rouleaux. Système adapté à la préparation des commandes, à l'augmentation de la rotation, de la productivité et de la capacité de stockage.





Le rayonnage Drive-in est conçu pour le stockage compact de produits homogènes, avec de grandes quantités de palettes de même référence.

Cette installation se compose d'un ensemble de rayonnages, qui forment des allées de charge intérieures, avec des rails support de palettes. Les chariots élévateurs à fourche entrent dans ces allées avec la charge surélevée par rapport au niveau où elle sera déposée.



RAYONNAGE MI-LOURD LT50

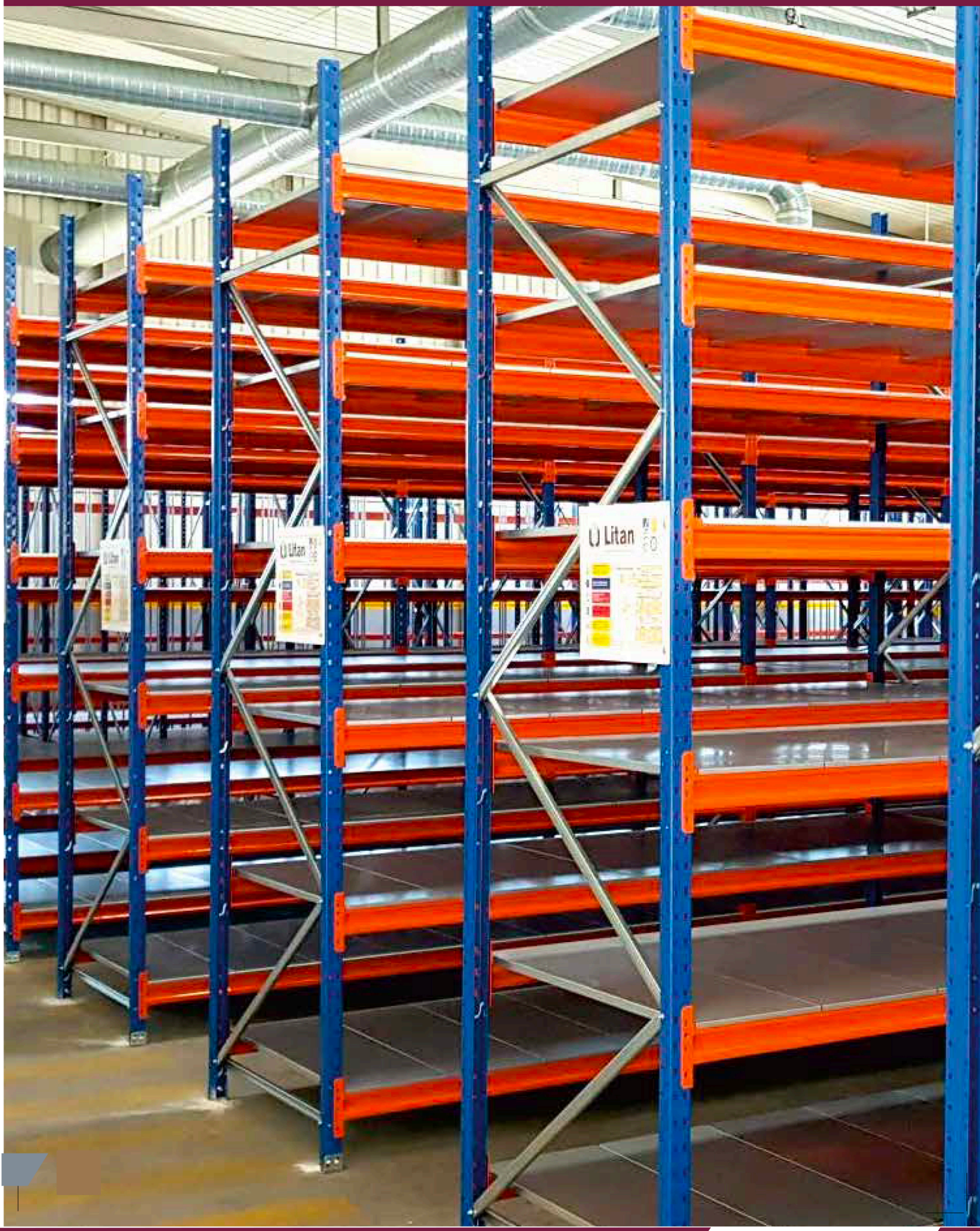

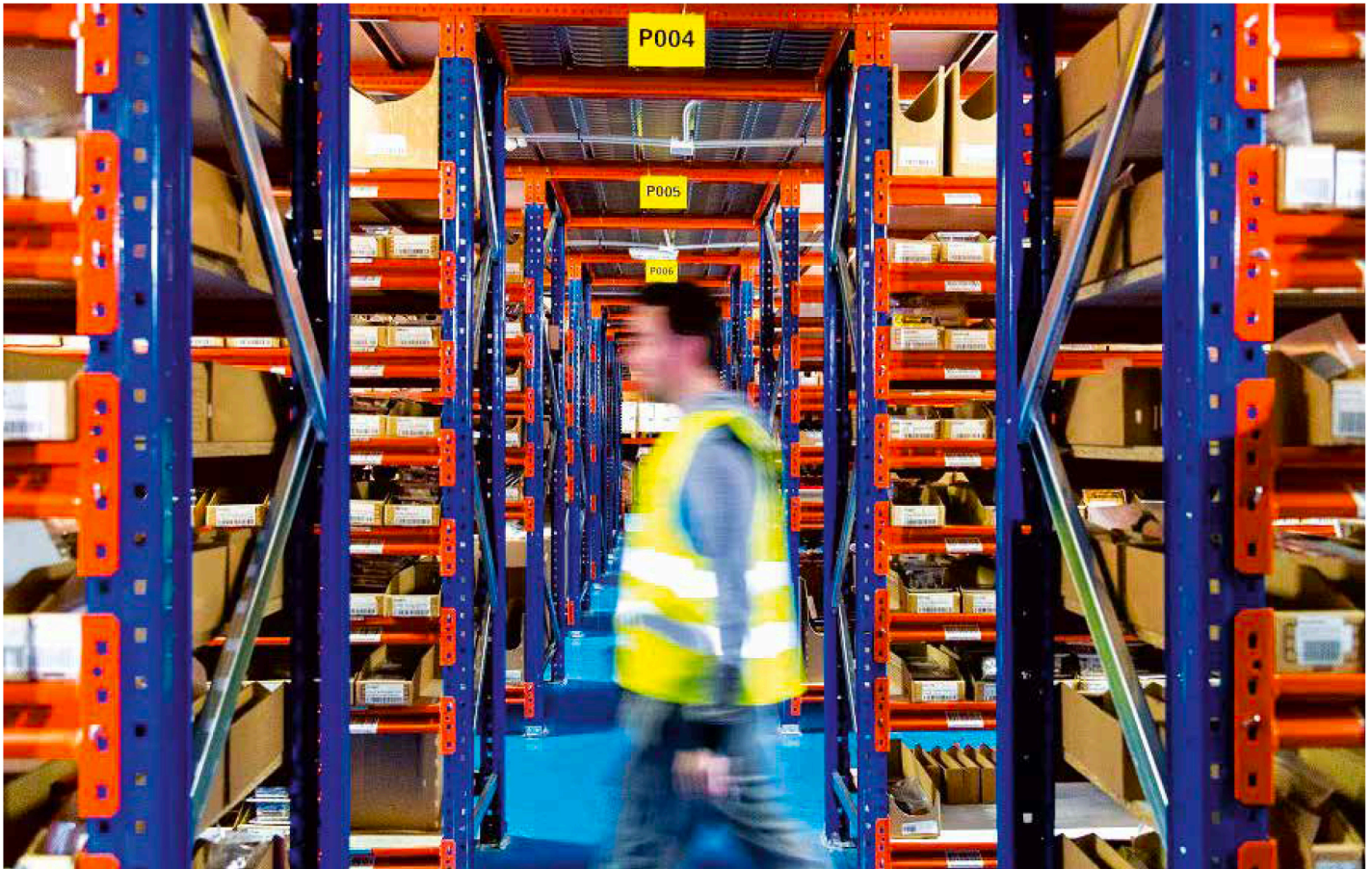

Les rayonnages Carla Média / Picking, entièrement réglables, sont conçus pour les entrepôts où les marchandises sont déposées et retirées manuellement.

Ce système est extrêmement polyvalent et adaptable aux charges moyennes et légères.

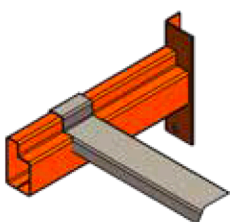

Renfort LT74

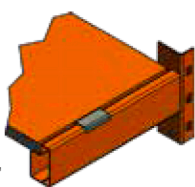

Renfort Z80

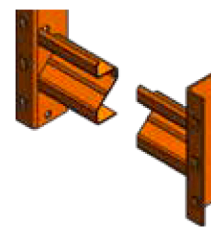
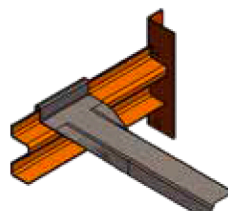
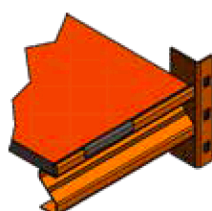

Larguero Z80

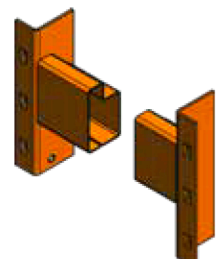

Larguero LT74

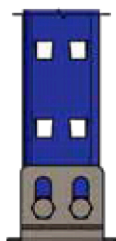

Montant LT50

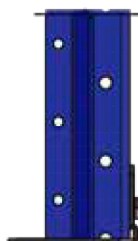

Montant PKU55

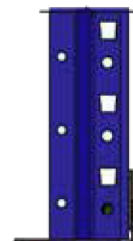

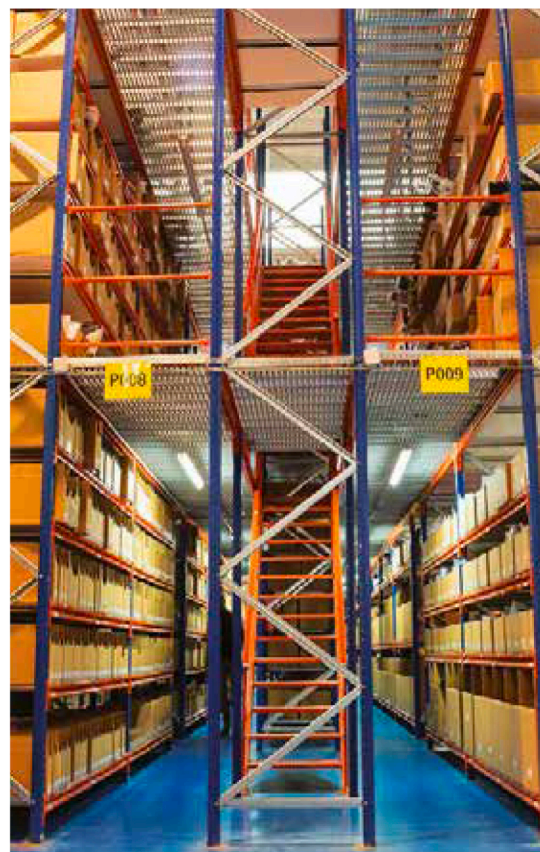

L'installation d'une passerelle constitue la solution idéale pour une meilleure utilisation d'une surface de stockage ou d'un entrepôt, car ceci permet de profiter au maximum de la hauteur de la construction existante par la création de différents niveaux.



Système formé de montants et de bras horizontaux, conçu pour stocker des produits de grandes longueurs, tels que : tuyaux, profilés divers, tasseaux, rouleaux de matériaux stratifiés, etc ...

Il est développé en fonction du poids et des dimensions des produits à stocker, en offrant la possibilité de placer des bras de part et d'autre du rack.

Les nombreuses possibilités de réglage des profilés, aussi bien en hauteur qu'en longueur, permettent de stocker tout type de produit.

Grâce à ses caractéristiques physiques, il possède une grande stabilité mécanique, il n'est pas nécessaire de le fixer à la construction existante ou à d'autres éléments structurels, il fonctionne de manière autonome.



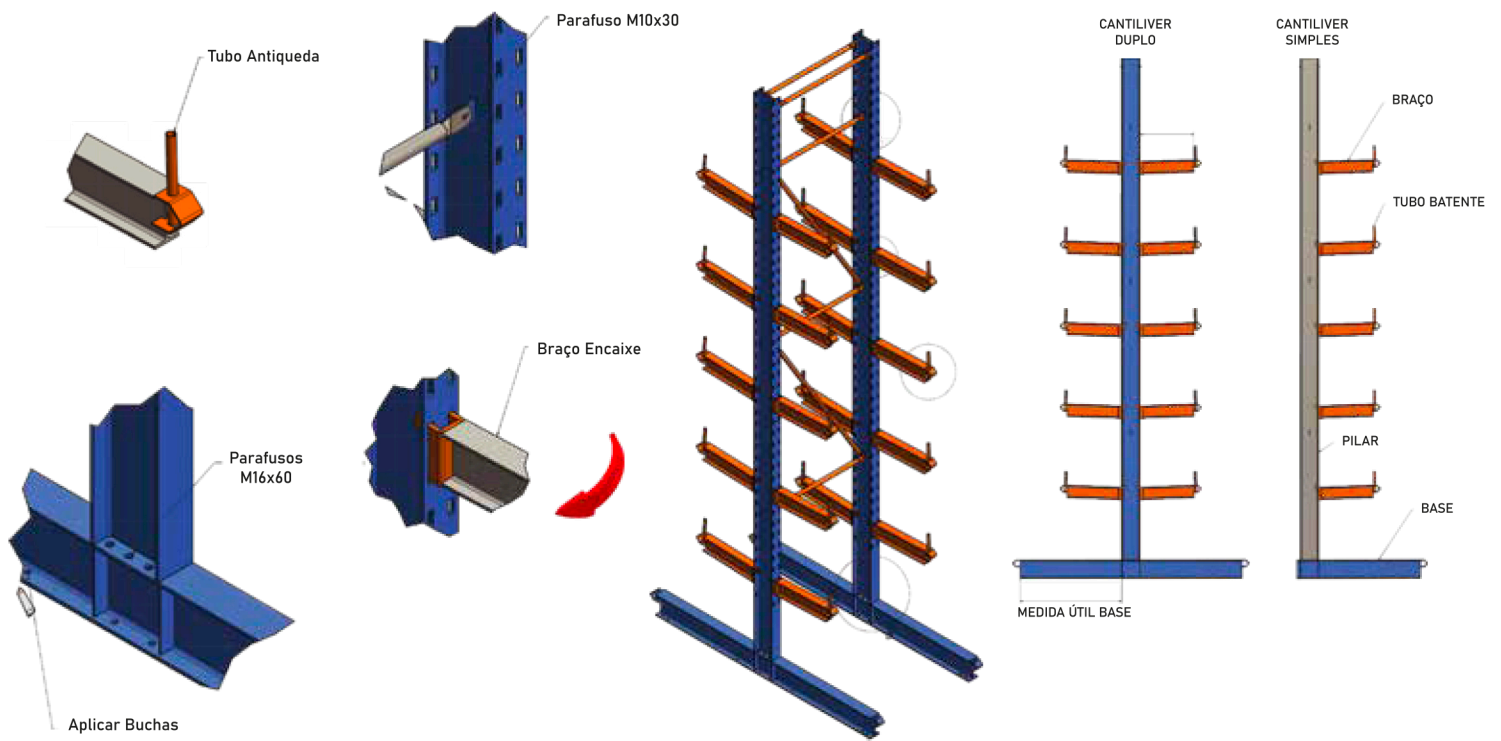

Système formé par des montants et des bras horizontaux, conçu pour stocker des produits de grandes longueurs, tels que : tuyaux, profilés divers, tasseaux, rouleaux de matériaux stratifiés, etc... . Il est développé en fonction du poids et des dimensions des produits à stocker, offrant la possibilité de placer des bras de part et d'autre du rack. Les nombreuses possibilités de réglage des profilés, aussi bien en hauteur qu'en longueur, permettent de stocker tout type de produit. Grâce à ses caractéristiques physiques, il possède une grande stabilité mécanique, il n'est pas nécessaire de le fixer à la construction existante ou à autres éléments structurels, il fonctionne de manière autonome.

Cantilever's Simples

Carga Max. Nivel 1200Kg

Cantilever's Duplo

Carga Max. Nivel 1200Kg

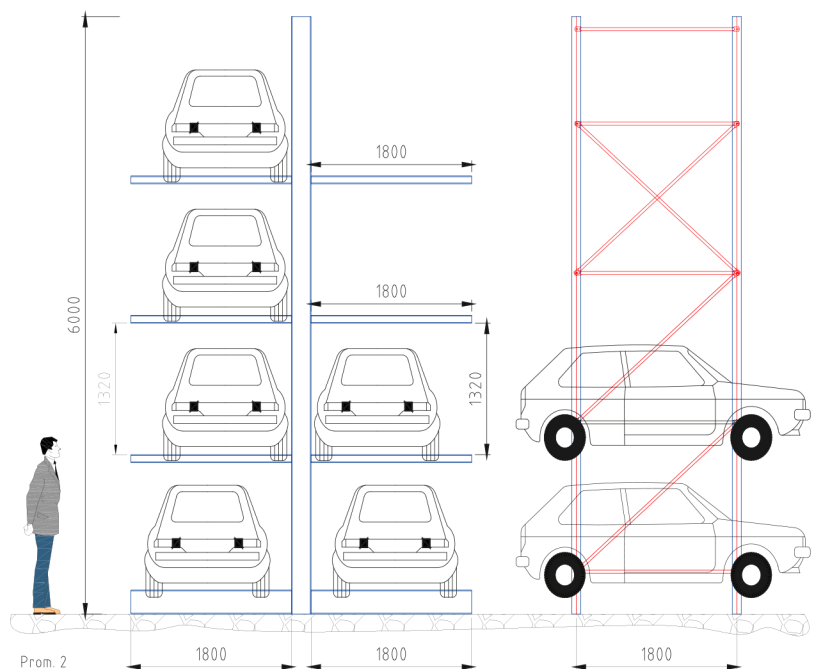
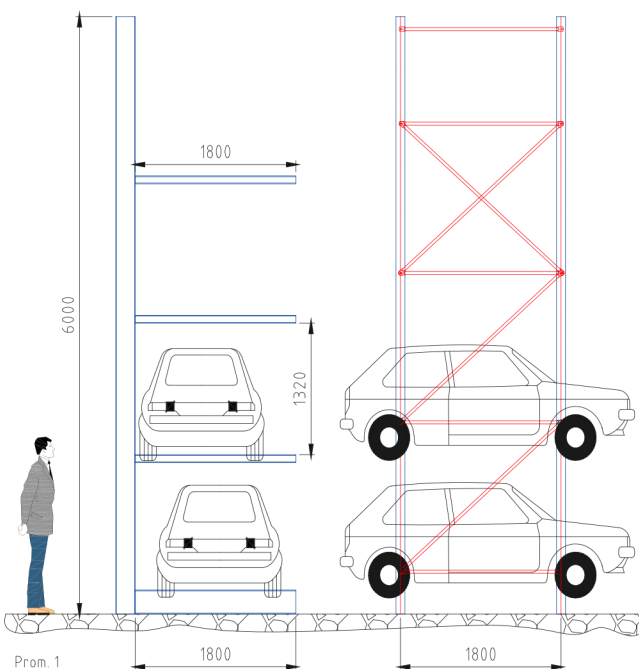

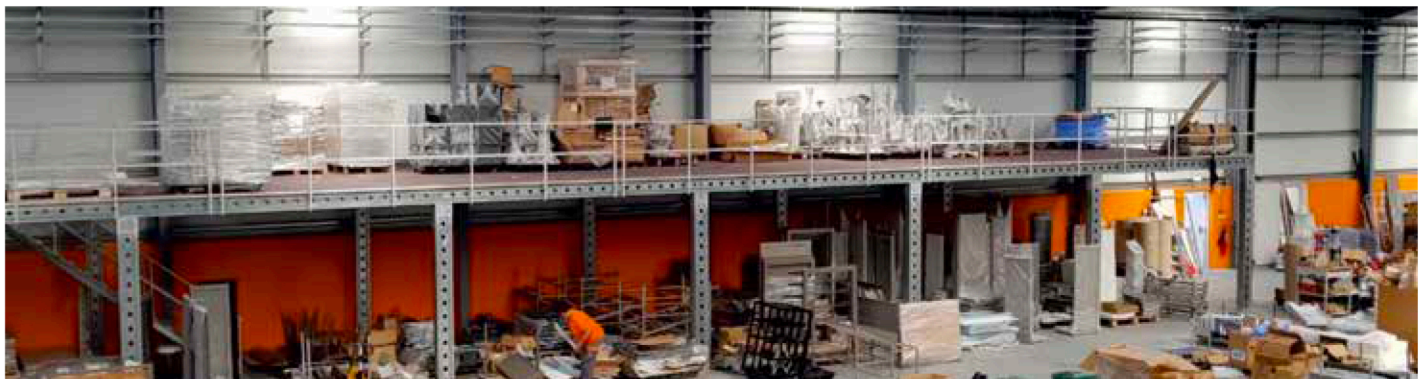
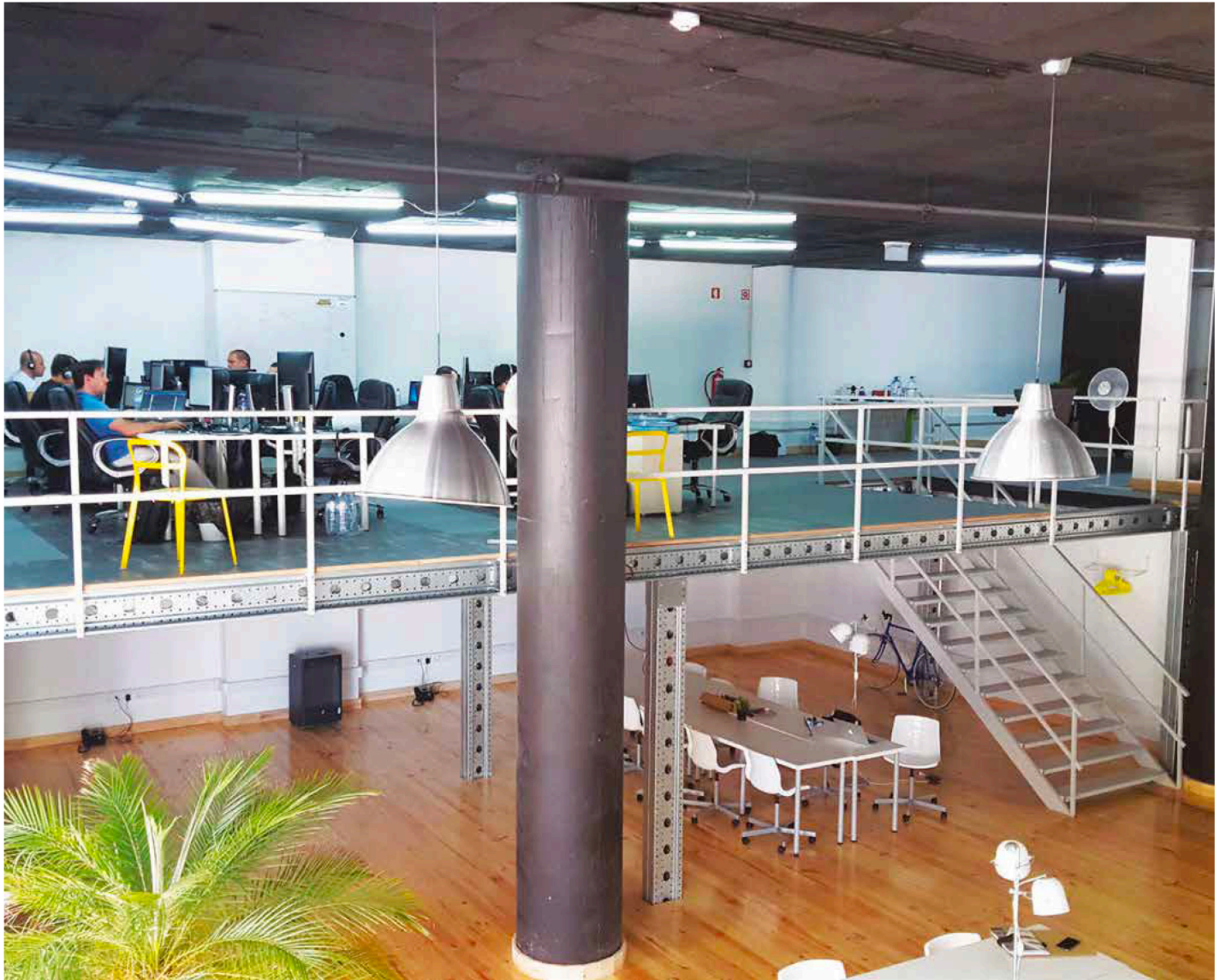

L'installation d'une plateforme représente la solution idéale pour utiliser au mieux une surface de stockage ou un entrepôt.

Les plateformes SIGMA LITAN sont des systèmes entièrement démontables et réutilisables, la structure, les dimensions ou l'espace sont facilement modifiables.



Système basique de stockage manuel destiné aux charges moyennes ou légères. D'une finition parfaite et d'une grande stabilité, il offre différentes options de dimensions des lisses: 1200mm, 1500mm, 1800mm et 2100mm.



Étagères conventionnelles

Litan Estantes Metálicas conçoit et développe tout système selon les besoins spécifiques de chaque client.



Étagères conventionnelles



Porte-pneus

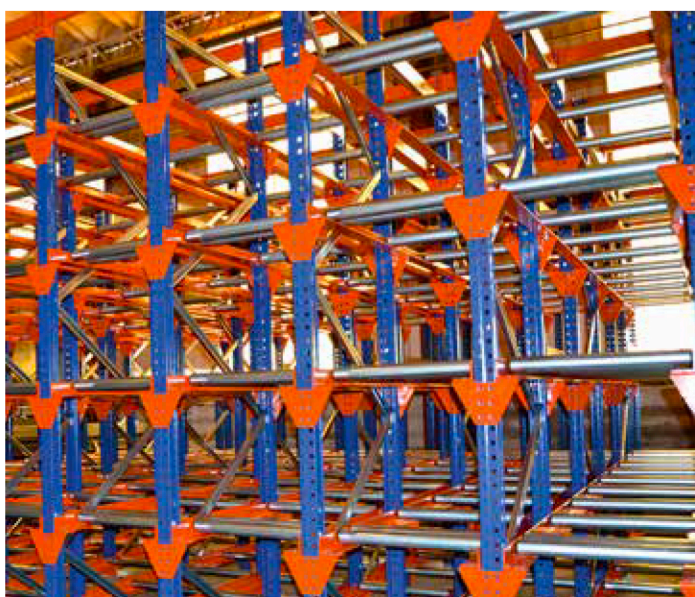

Étagère pour le rangement des fers



Rayonnage à rouleaux en tissu

FABRICANT D'ÉCHELLES EN ALUMINIUM



WWW.LITAN.PT



Consultez nos solutions d'échelles et d'escabeaux.

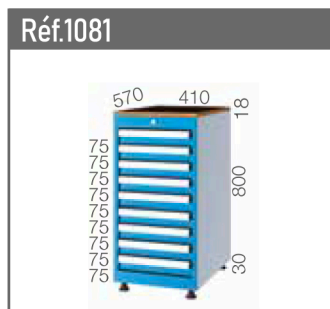





SCÉNARIOS D'UTILISATION





88, Lotissement Mauritania

Z.I El bernoussi - Ain Sebâa - 20590

Casablanca - MAROC

Tél. : 05 22 35 25 48

Fax : 05 22 35 25 17

Email : info@cedis.ma

www.cedis.ma